

## LED Panel Light

- ▶ Ultra thin design, thickness is only 10.5mm.
- ▶ Edison SMD2835 led chips, high reliability  
CRI>90
- ▶ Long lifetime over 50,000 hrs, extremely low maintenance cost.
- ▶ No-flickering or buzzing and RF interference.
- ▶ Dimmable available
- ▶ Suitable for general lighting, such as home, office,
- ▶ 5 Years warranty



## 1. Technical Data



Model No.	BLP-PL6060N6	BLP-PL6060N6	BLP-PL30120N5	BLP-PL30120N5
Dimension:	595x595x10.5mm	595x595x10.5mm	295x1195x10.5mm	295x1195x10.5mm
Material:	Aluminium + Acrylic	Aluminium + Acrylic	Aluminium + Acrylic	Aluminium + Acrylic
Surface Treatment:	Anodic Oxidation	Anodic Oxidation	Anodic Oxidation	Anodic Oxidation
Colour Temperature:	3000K/4000K/5700K	3000K/4000K/5700K	3000K/4000K/5700K	3000K/4000K/5700K
Colour:	WW/W/CW	WW/W/CW	WW/W/CW	WW/W/CW
Beam Angle:	120°	120°	120°	120°
CRI:	≥90	≥90	≥90	≥90
LED Luminous Flux :	4100-4600lm	5000-5500lm	4000-4400lm	4700-5200lm
Power:	40W	50W	40W	50W
LED Type:	Edison 2835	Edison 2835	Edison 2835	Edison 2835
LED Qty:	480 pcs	480 pcs	480 pcs	480 pcs
Voltage:	AC100-240V	AC100-240V	AC100-240V	AC100-240V
Power Factor:	>0.95	>0.95	>0.95	>0.95
Work Temperature:	-20°C ~ +40°C	-20°C ~ +40°C	-20°C ~ +40°C	-20°C ~ +40°C
Lifespan:	50,000 Hrs	50,000 Hrs	50,000 Hrs	50,000 Hrs
Net Weight:	3.6 Kg	3.6 Kg	3.6 Kg	3.6 Kg
Install type:	Pendant/Recessed/Mounting	Pendant/Recessed/Mounting	Pendant/Recessed/Mounting	Pendant/Recessed/Mounting

## 2. Photometric distribution

BLP-PL6060N6-40W

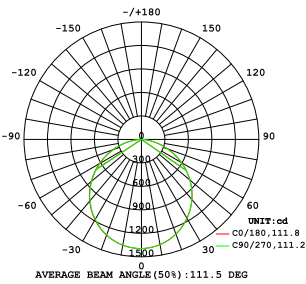

BLP-PL6060N6-50W

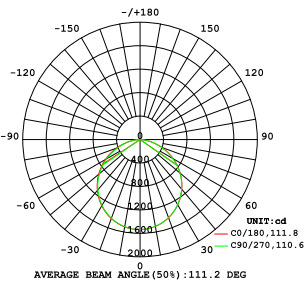

BLP-PL30120N5-40W

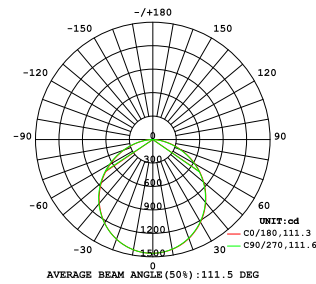

BLP-PL30120N5-50W

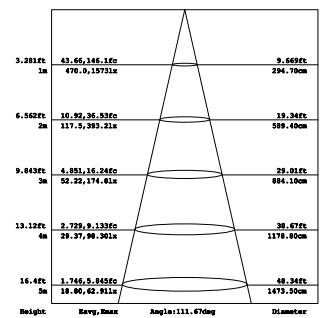
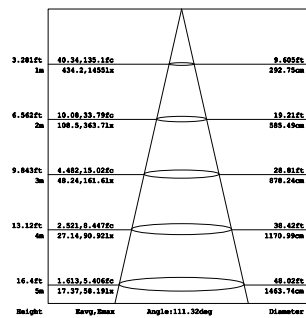
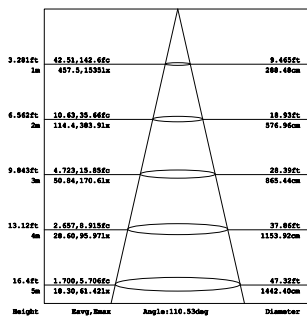
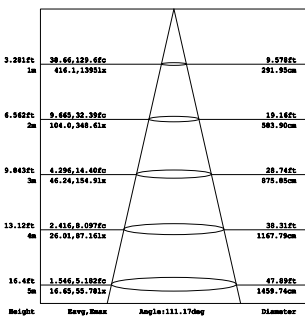
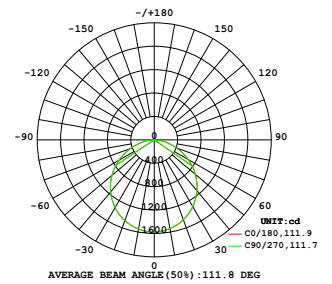

### 3. Dimension

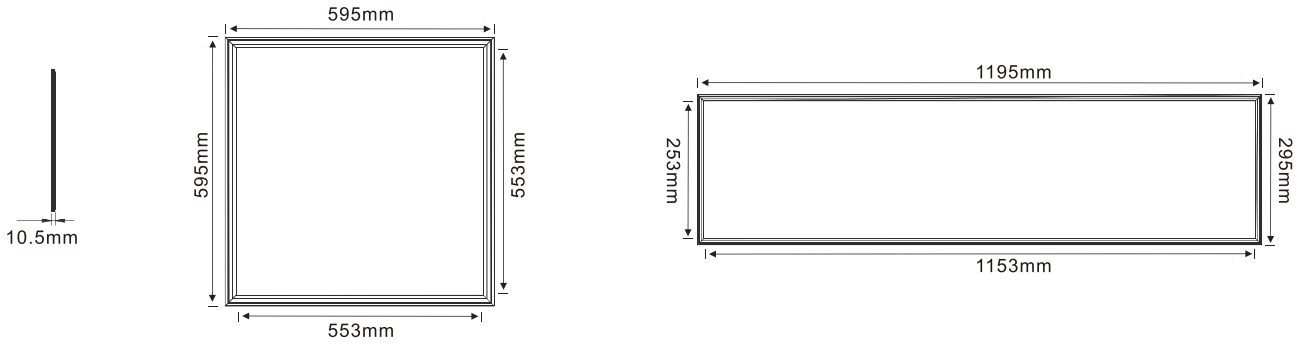

### 4. Connection Diagram

#### 1). Triac dimmable

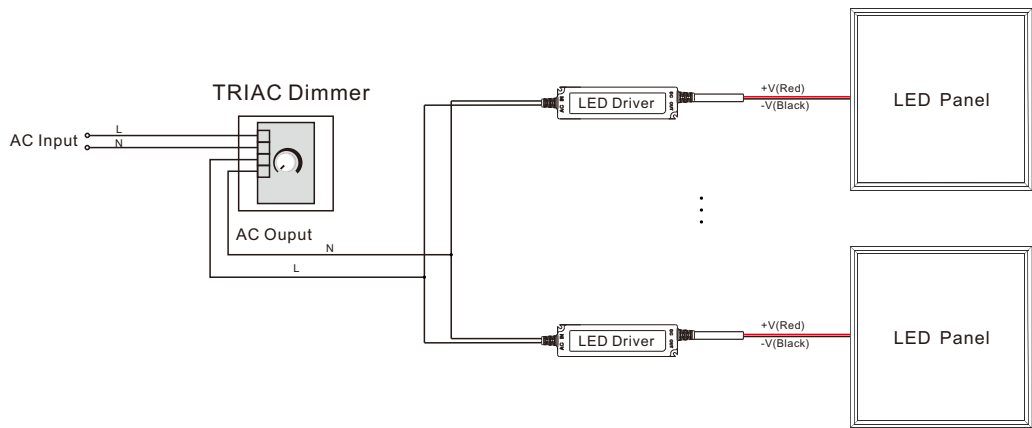

#### 2). Non-dimmable

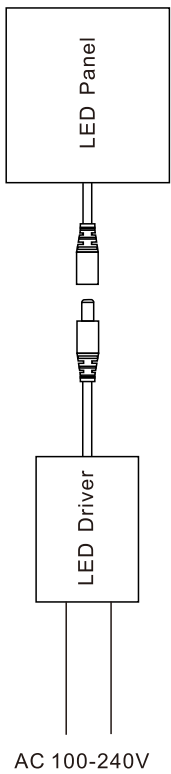

#### 3). 1-10VDC, PWM dimmable

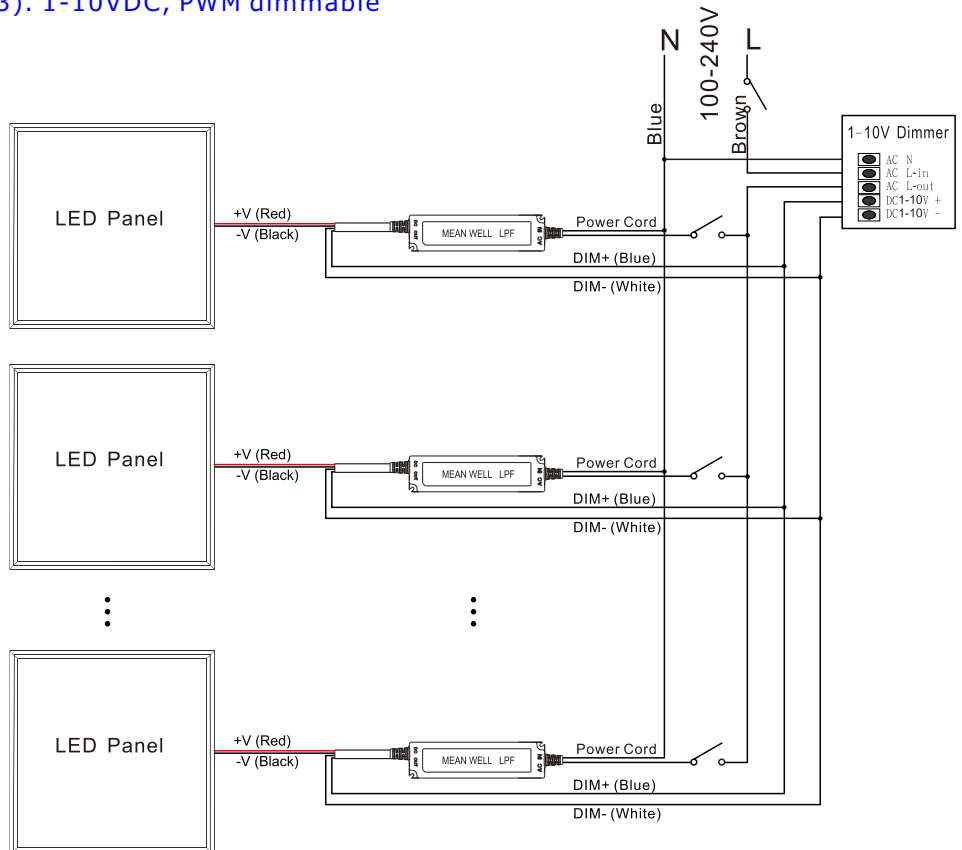

## 5. Installation Method

### 1). Recessed Installation

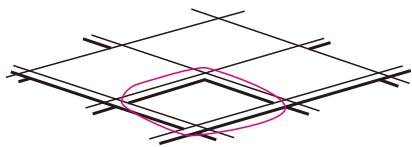

Step1. Remove the ceiling plaster slab

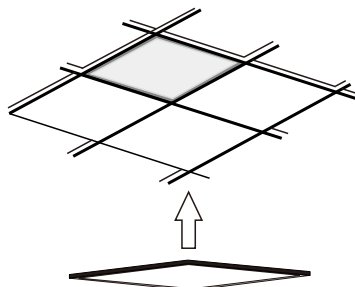

Step2. Place the panel on the ceiling system

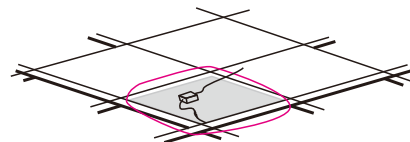

Step3. Connect the wires and test.

### 2). Pendant Installation

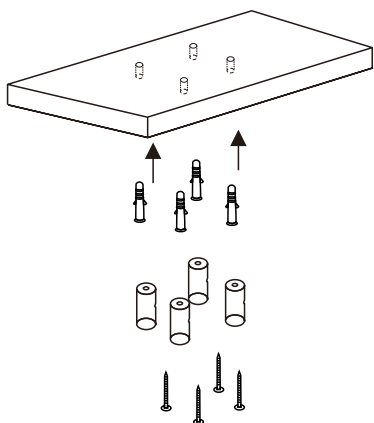

Step1. Fix the pendant accessories to the ceiling

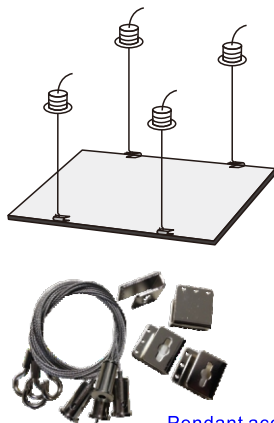

Step2. Fix the pendant accessories on the panel

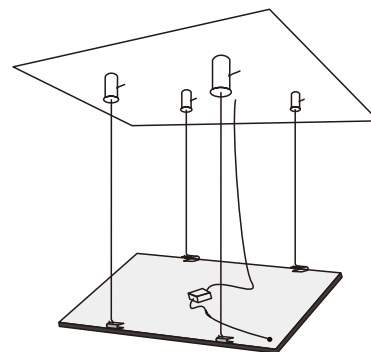

Step3. Screw up the nuts and connect the cable.

Pendant accessories

### 3). Mounting Installation

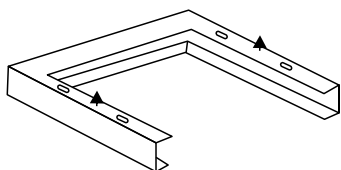

Step1. Fix the mounting frame on the ceiling

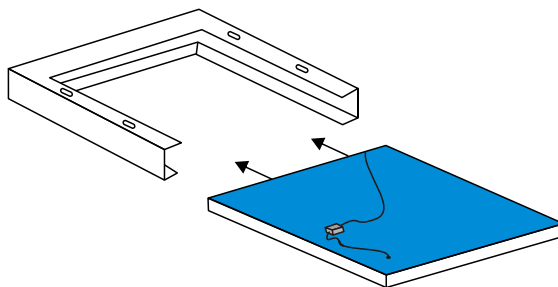

Step2. Connect the cables

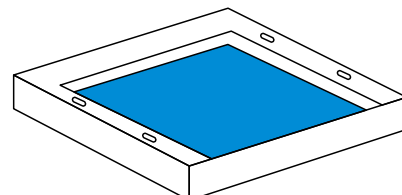

Step3: Insert the panel in the mounting frame and assemble the final frame

#### Note:

1. Open the box and check your product before installation. In case of damage, contact your merchandiser.
2. Remove the blue protection film on the backside for better heat dissipation purpose.

## 6. Safety Regulations

1. Installation and maintenance must be performed by professionals only.
2. Please make sure the lamp is working with correct input voltage.
3. Keep away from open flames or external heat sources.
4. Never leave children unattended in the vicinity of the lights and do not allow them to play with electrical devices.
5. Do not use chemicals or corrosive cleaner to clean the fixture.

